

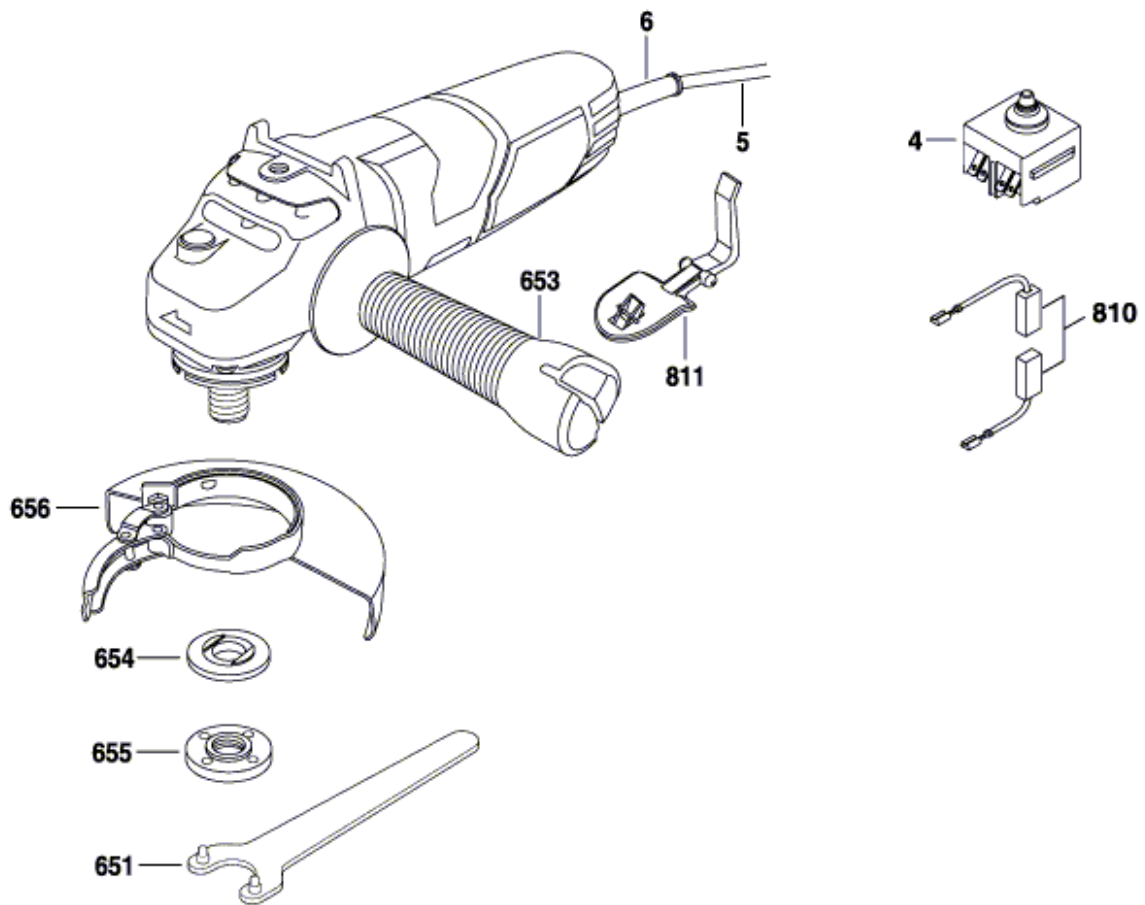

Product Description: Angle Grinder
Model Number: 9296-01
Body Number: 0080227004
Version: A
Issue Date: 2012/10/17



No.	Product Model#	Part Number	Description	Qty
4	9296-01	4870696023	Switch	1
5	9296-01	4810237018	Power supply cord	1
6	9296-01	3130253092	Cord guard	1
651	9296-01	5680258008	Pin-type face-wrench	1
653	9296-01	3130253093	Auxiliary handle	1
654	9296-01	3580000012	Flange	1
655	9296-01	3580000013	Flange	1
656	9296-01	3130253094	Safety guard	1
810	9296-01	4960384010	Carbon-brush set	2
811	9296-01	3130253095	Trigger	1